

# Wireless Basics and Models

## Chapter 2



# Overview

---

- Frequencies
- Signals
- Antennas
- Signal propagation
  
- Multiplexing
- Modulation
  
- Models, models, models



# Physical Layer: Wireless Frequencies

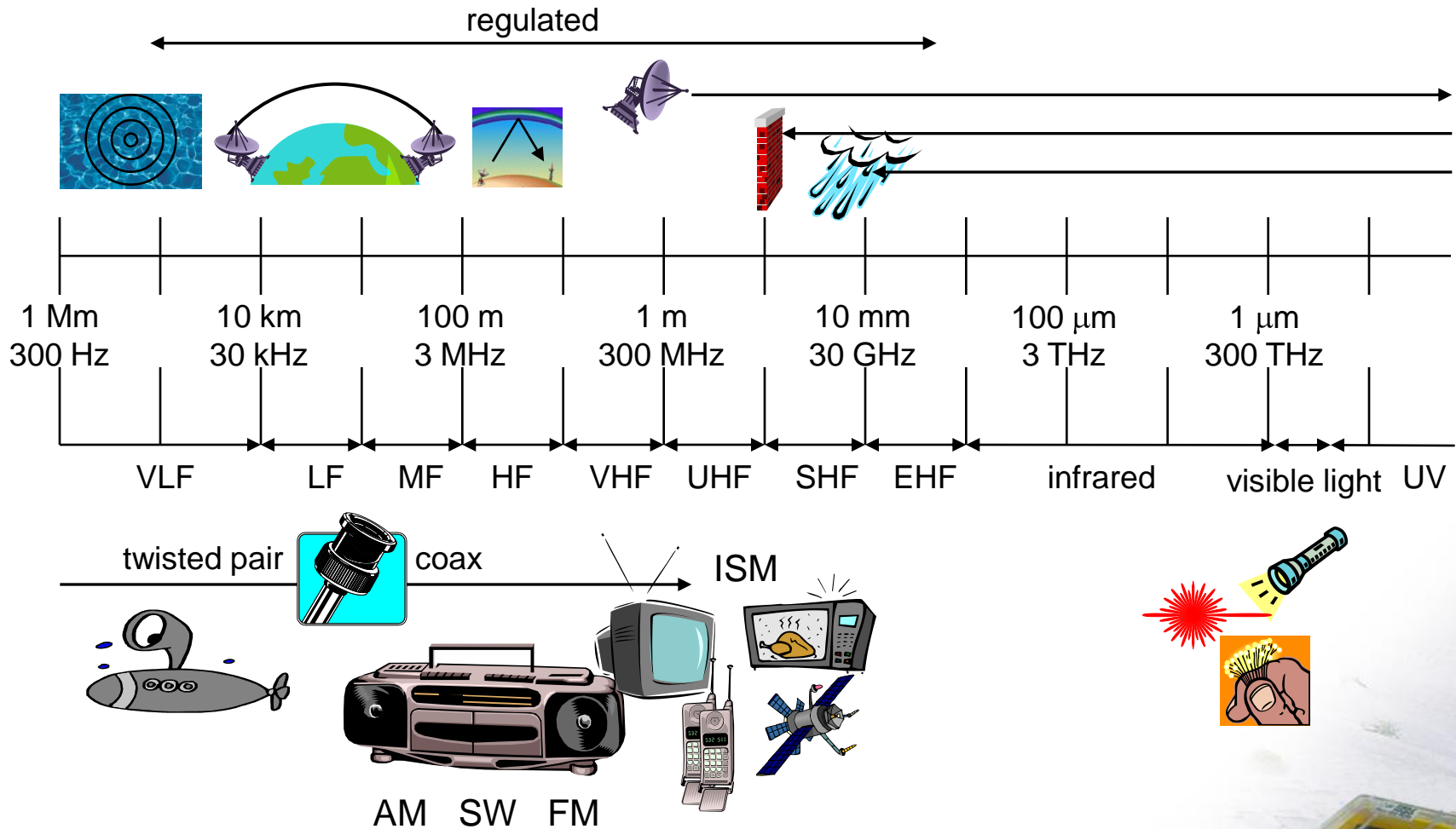

# Frequencies and Regulations

- ITU-R holds auctions for new frequencies, manages frequency bands worldwide (WRC, World Radio Conferences)

	Europe (CEPT/ETSI)	USA (FCC)	Japan
<b>Mobile phones</b>	<b>NMT</b> 453-457MHz, 463-467 MHz <b>GSM</b> 890-915 MHz, 935-960 MHz, 1710-1785 MHz, 1805-1880 MHz	<b>AMPS, TDMA, CDMA</b> 824-849 MHz, 869-894 MHz <b>TDMA, CDMA, GSM</b> 1850-1910 MHz, 1930-1990 MHz	<b>PDC</b> 810-826 MHz, 940-956 MHz, 1429-1465 MHz, 1477-1513 MHz
<b>Cordless telephones</b>	<b>CT1+</b> 885-887 MHz, 930-932 MHz <b>CT2</b> 864-868 MHz <b>DECT</b> 1880-1900 MHz	<b>PACS</b> 1850-1910 MHz, 1930-1990 MHz <b>PACS-UB</b> 1910-1930 MHz	<b>PHS</b> 1895-1918 MHz <b>JCT</b> 254-380 MHz
<b>Wireless LANs</b>	<b>IEEE 802.11</b> 2400-2483 MHz <b>HIPERLAN 1</b> 5176-5270 MHz	<b>IEEE 802.11</b> 2400-2483 MHz	<b>IEEE 802.11</b> 2471-2497 MHz



# Signal propagation ranges, a simplified model

- Propagation in free space always like light (straight line)
- Transmission range
  - communication possible
  - low error rate
- Detection range
  - detection of the signal possible
  - no communication possible
- Interference range
  - signal may not be detected
  - signal adds to the background noise

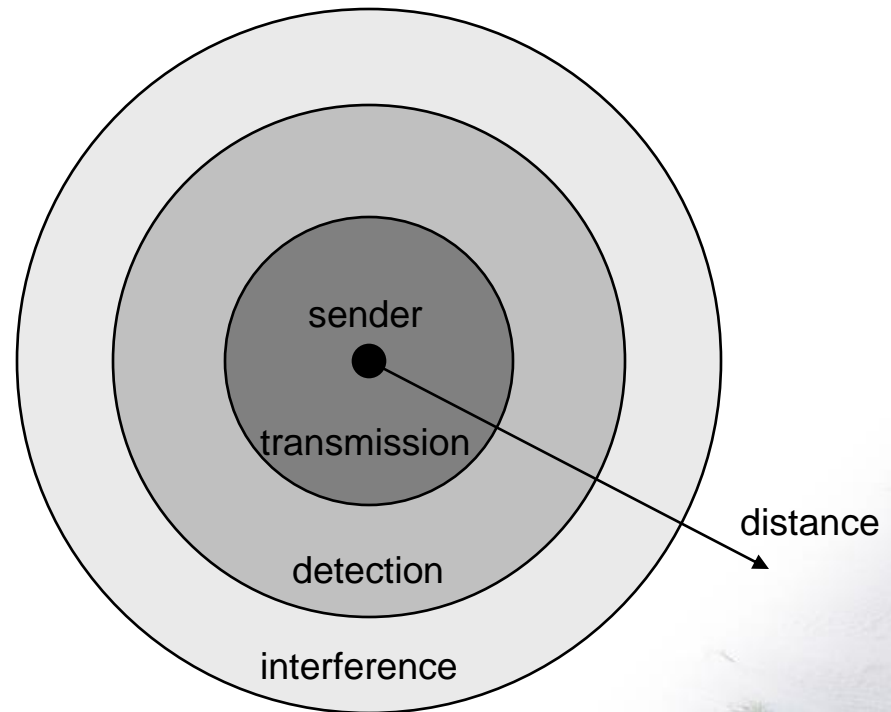

# Signal propagation, more accurate models

---

- **Free space propagation**  $P_r = \frac{P_s G_s G_r \lambda^2}{(4\pi)^2 d^2 L}$
- **Two-ray ground propagation**  $P_r = \frac{P_s G_s G_r h_s^2 h_r^2}{d^4}$
- $P_s, P_r$ : Power of radio signal of sender resp. receiver
- $G_s, G_r$ : Antenna gain of sender resp. receiver (how bad is antenna)
- $d$ : Distance between sender and receiver
- $L$ : System loss factor
- $\lambda$ : Wavelength of signal in meters
- $h_s, h_r$ : Antenna height above ground of sender resp. receiver
- Plus, in practice, received power is not constant („fading“)



# Attenuation by distance

- Attenuation [dB] =  $10 \log_{10}$  (transmitted power / received power)
- Example: factor 2 loss =  $10 \log_{10} 2 \approx 3$  dB
- In theory/vacuum (and for short distances), receiving power is proportional to  $1/d^2$ , where  $d$  is the distance.
- In practice (for long distances), receiving power is proportional to  $1/d^\alpha$ ,  $\alpha = 4 \dots 6$ . We call  $\alpha$  the path loss exponent.
- Example: Short distance, what is the attenuation between 10 and 100 meters distance?  
Factor 100 ( $=100^2/10^2$ ) loss = 20 dB

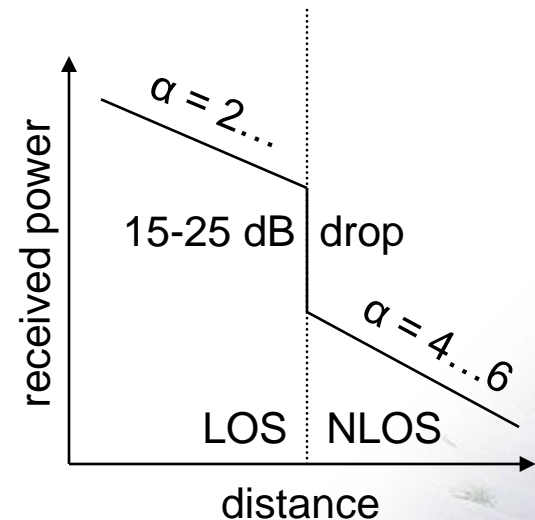

# Antennas: isotropic radiator

- Radiation and reception of electromagnetic waves, coupling of wires to space for radio transmission
- Isotropic radiator: equal radiation in all three directions
- Only a theoretical reference antenna
- Radiation pattern: measurement of radiation around an antenna
- Sphere:  $S = 4\pi r^2$

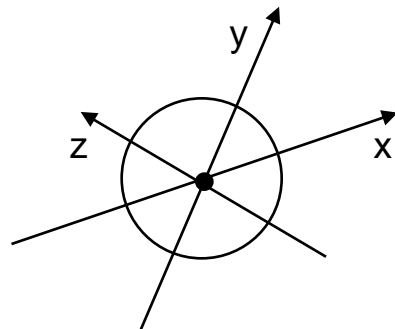
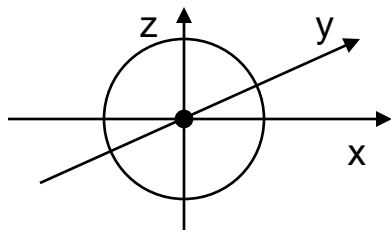

ideal  
isotropic  
radiator





# Antennas: simple dipoles

- Real antennas are not isotropic radiators but, e.g., dipoles with lengths  $\lambda/2$  as Hertzian dipole or  $\lambda/4$  on car roofs or shape of antenna proportional to wavelength



- Example: Radiation pattern of a simple Hertzian dipole

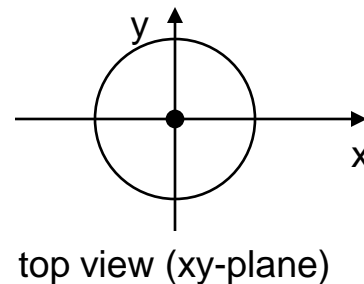
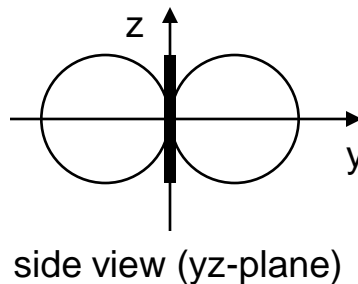
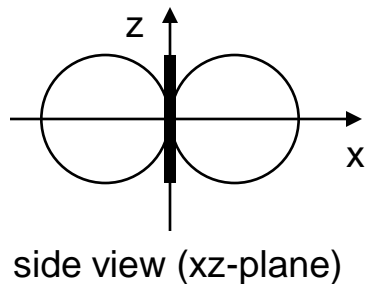

simple  
dipole



# Antennas: directed and sectorized

- Often used for microwave connections or base stations for mobile phones (e.g., radio coverage of a valley)

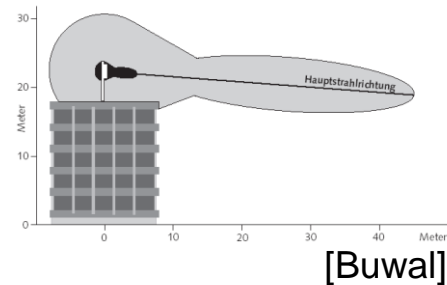
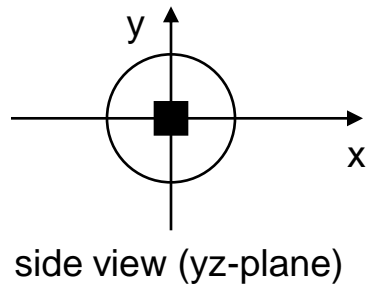
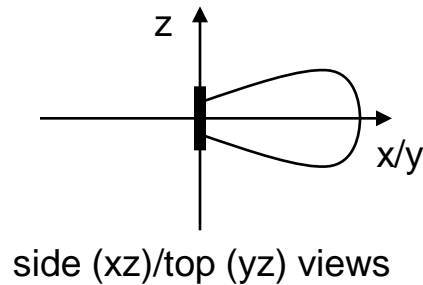

directed antenna

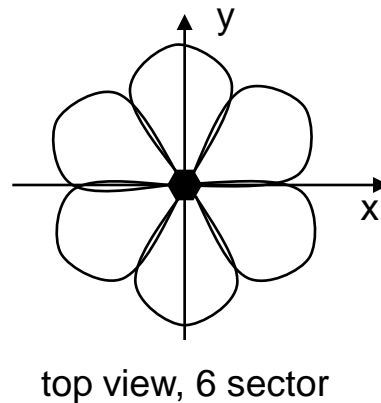
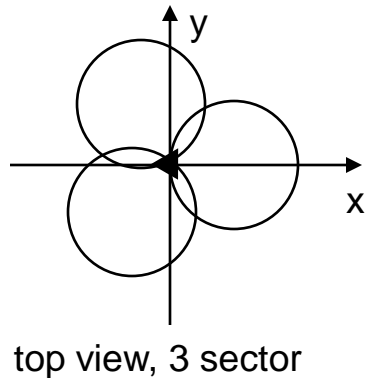

sectorized antenna



# Antennas: diversity

- Grouping of 2 or more antennas
  - multi-element antenna arrays
- Antenna diversity
  - switched diversity, selection diversity
    - receiver chooses antenna with largest output
  - diversity combining
    - combine output power to produce gain
    - cophasing needed to avoid cancellation

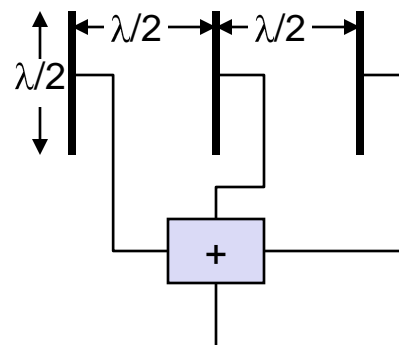
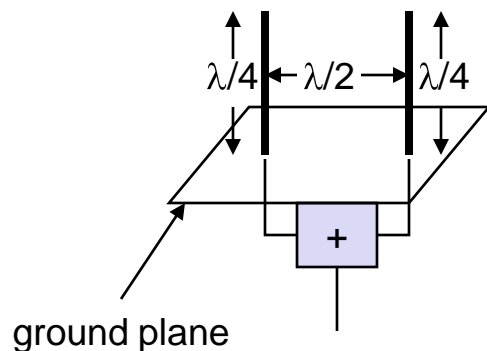

- Smart antenna: beam-forming, MIMO, etc.



# Real World Examples

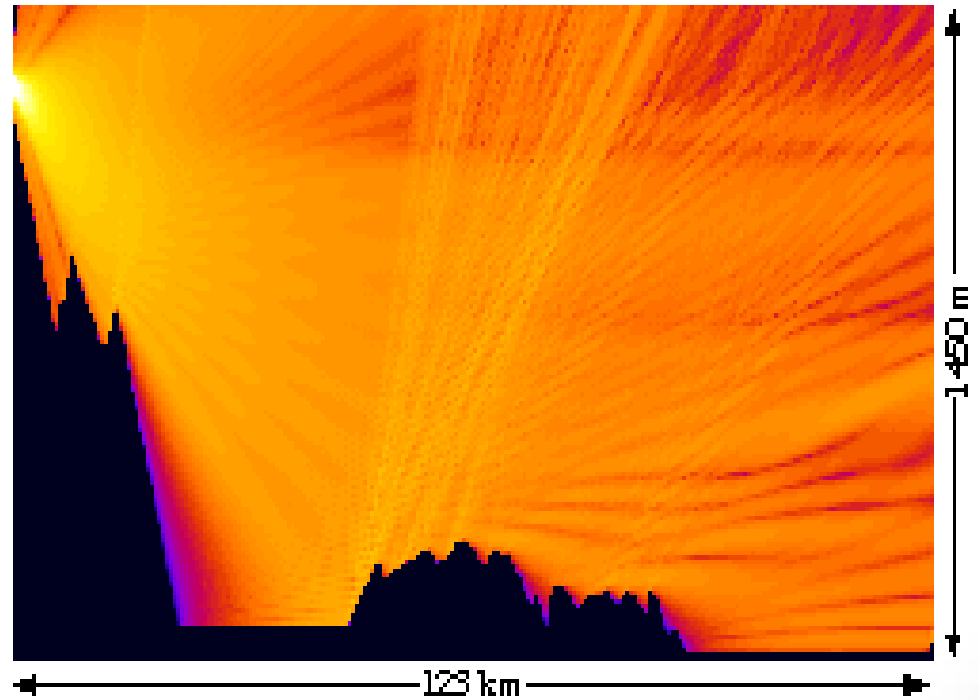
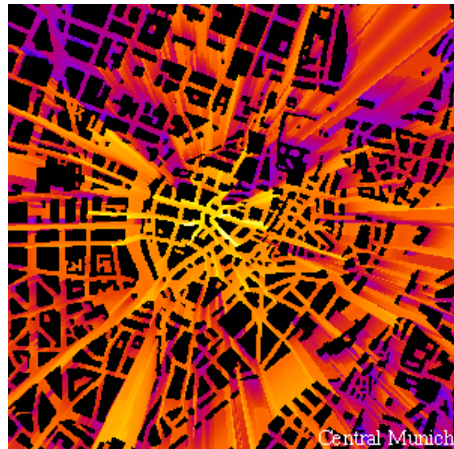
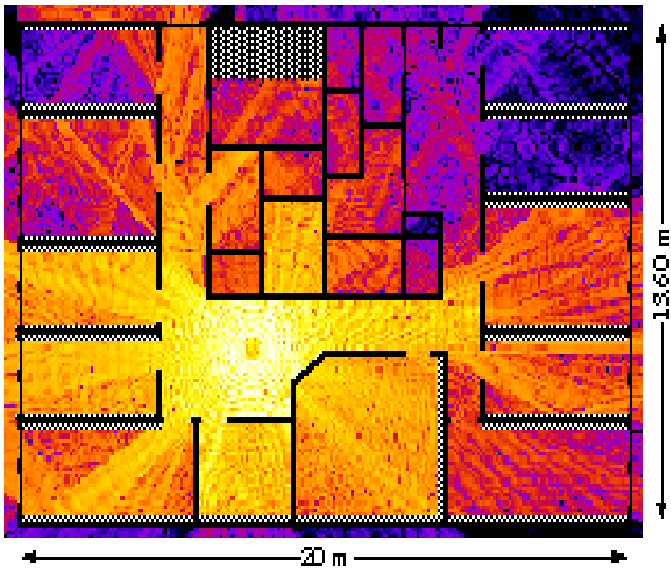

# Attenuation by objects

- Shadowing (3-30 dB):
  - textile (3 dB)
  - concrete walls (13-20 dB)
  - floors (20-30 dB)
- reflection at large obstacles
- scattering at small obstacles
- diffraction at edges
- fading (frequency dependent)

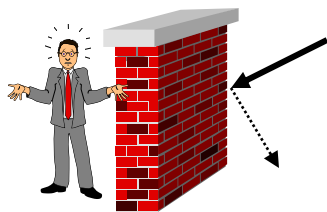

shadowing

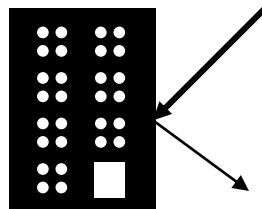

reflection



scattering



diffraction



# Multipath propagation

- Signal can take many different paths between sender and receiver due to reflection, scattering, diffraction

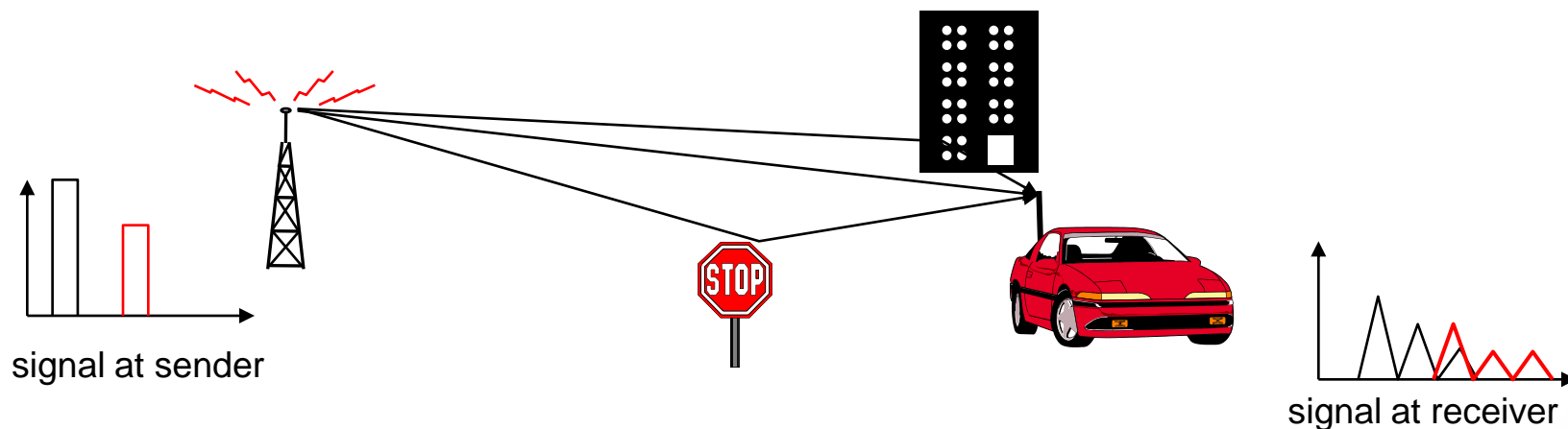

- Time dispersion: signal is dispersed over time
- Interference with “neighbor” symbols: Inter Symbol Interference (ISI)
- The signal reaches a receiver directly and phase shifted
- Distorted signal depending on the phases of the different parts

# Effects of mobility

- Channel characteristics change over time and location
  - signal paths change
  - different delay variations of different signal parts
  - different phases of signal parts
- quick changes in power received (short term fading)
- Additional changes in
  - distance to sender
  - obstacles further away
- slow changes in average power received (long term fading)
- Doppler shift: Random frequency modulation

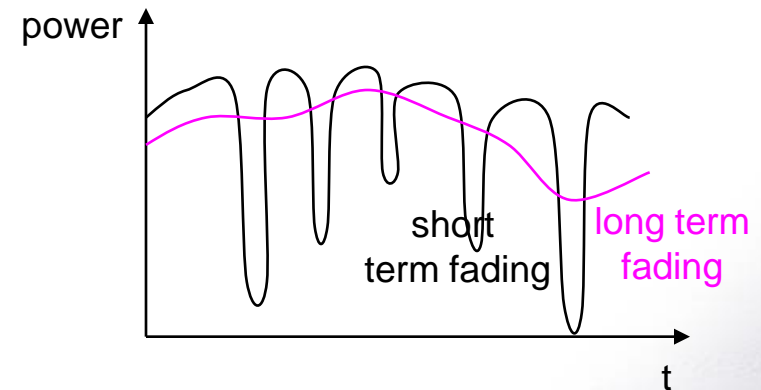

# Multiplexing

- Multiplex channels ( $k$ ) in four dimensions
  - space ( $s$ )
  - time ( $t$ )
  - frequency ( $f$ )
  - code ( $c$ )
- Goal: multiple use of a shared medium
- Important: guard spaces needed!
- Example: radio broadcast

channels  $k_i$

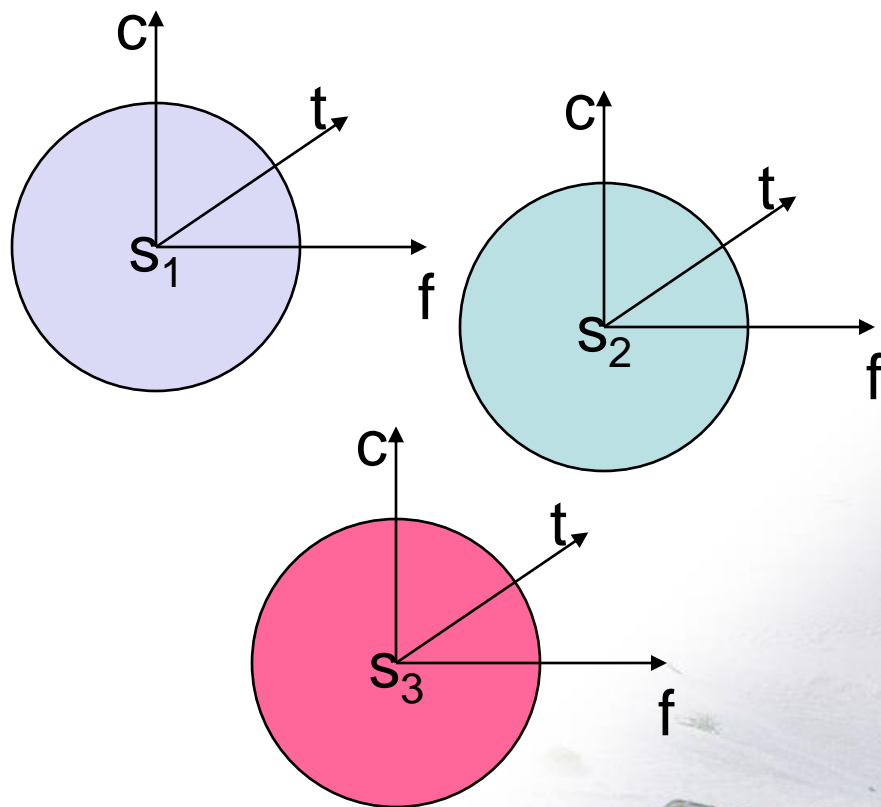
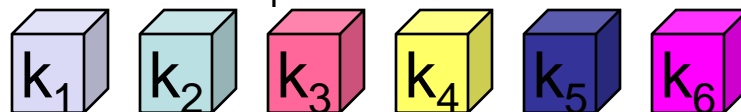



# Example for space multiplexing: Cellular network

- Simplified hexagonal model
- Signal propagation ranges:  
Frequency reuse only with a certain distance between the base stations
- Can you reuse frequencies in distance 2 or 3 (or more)?
- Graph coloring problem
- Example: fixed frequency assignment for reuse with distance 2
- Interference from neighbor cells (other color) can be controlled with transmit and receive filters

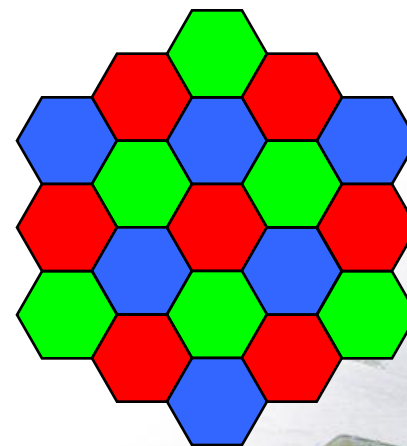
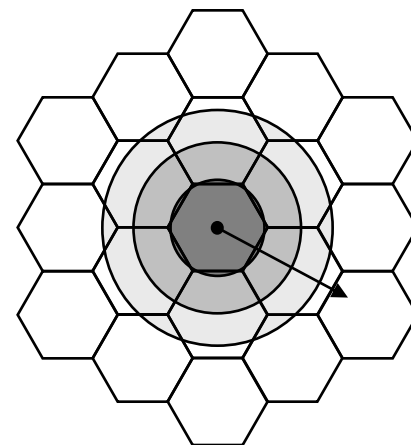

# Carrier-to-Interference / Signal-to-Noise

- Digital techniques can withstand a Carrier-to-Interference ratio of approximately 9 dB.
- Assume the path loss exponent  $\alpha = 3$ . Then,

$$\frac{C}{I} = \frac{(D - R)^\alpha}{R^\alpha} = \left(\frac{D}{R} - 1\right)^\alpha$$

which gives  $D/R = 3$ . Reuse distance of 2 might just work...

- Remark: Interference that cannot be controlled is called *noise*. Similarly to  $C/I$  there is a signal-to-interference ratio  $S/I$  (SNR).

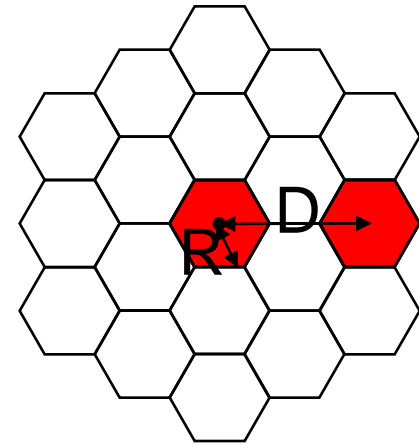

# Frequency Division Multiplex (FDM)

- Separation of the whole spectrum into smaller frequency bands
- A channel gets a certain band of the spectrum for the whole time
- + no dynamic coordination necessary
- + works also for analog signals
- waste of bandwidth if traffic is distributed unevenly
- inflexible
- Example:  
broadcast radio

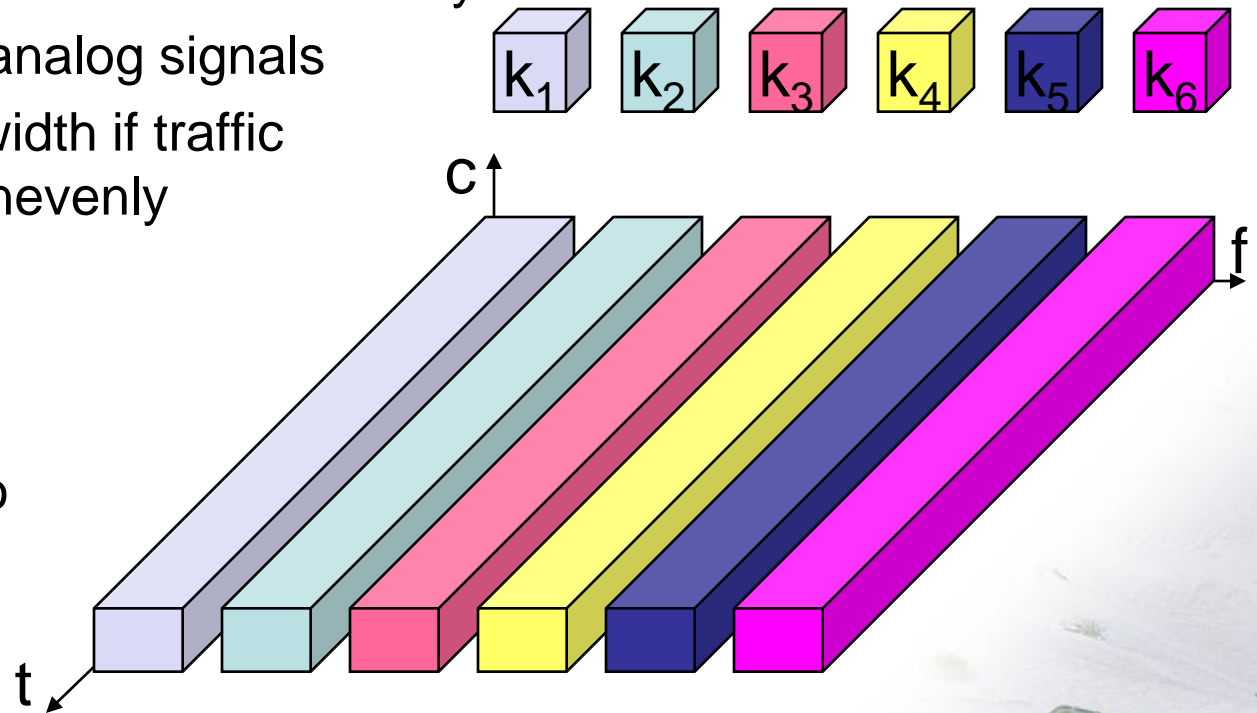

# Time Division Multiplex (TDM)

- A channel gets the whole spectrum for a certain amount of time
- + only one carrier in the medium at any time
- + throughput high even for many users
- precise synchronization necessary

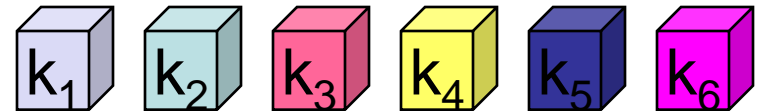

- Example: Ethernet

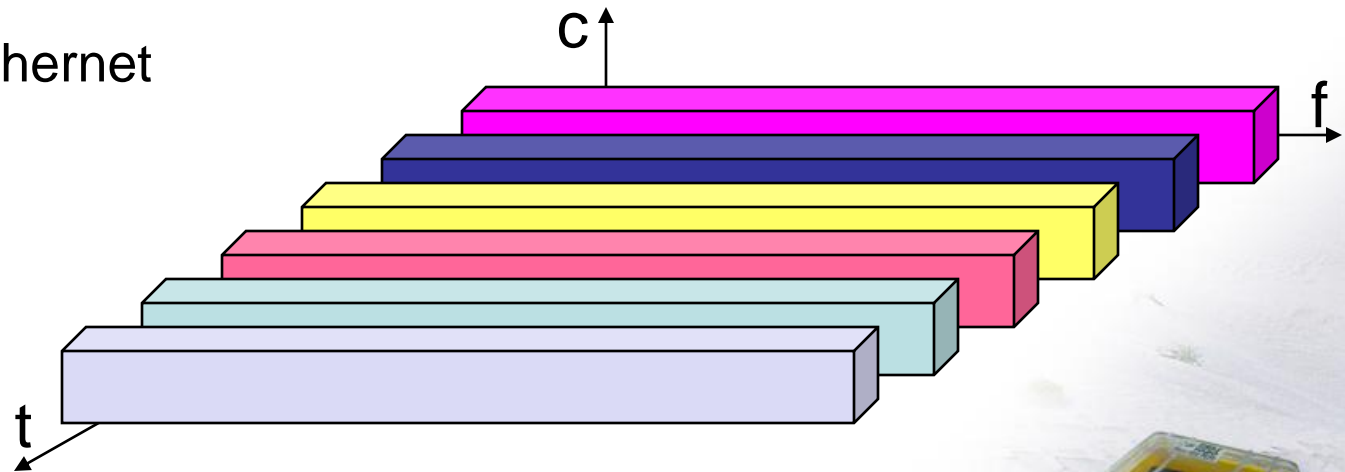

# Time and Frequency Division Multiplex

- Combination of both methods
- A channel gets a certain frequency band for some time
- + protection against frequency selective interference
- + protection against tapping
- + adaptive
- precise coordination required

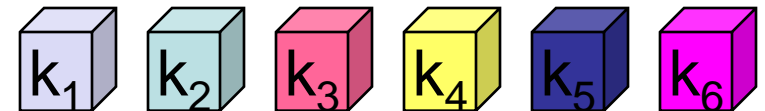

- Example: GSM

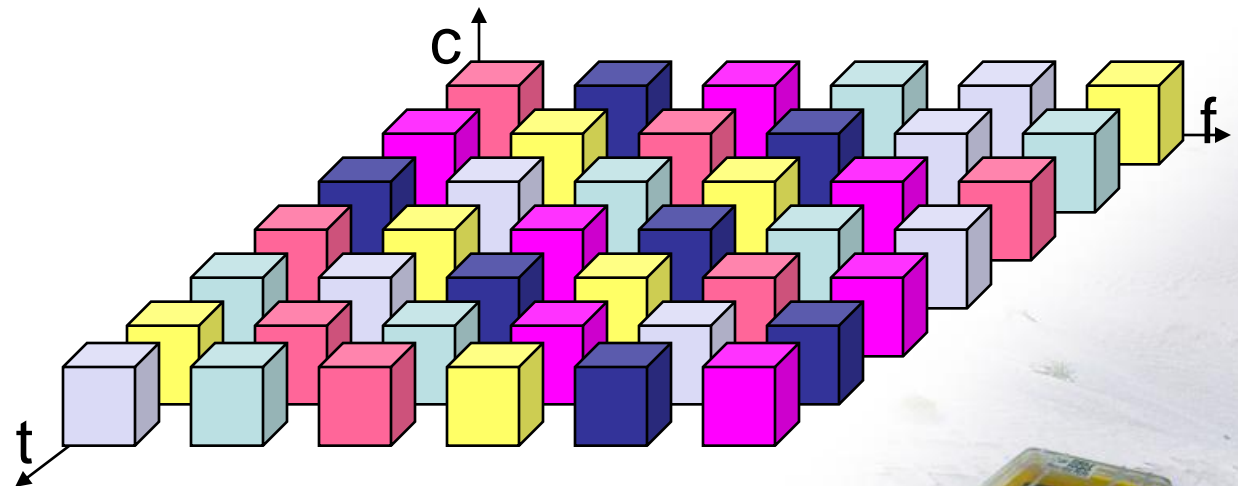

# Code Division Multiplex (CDM)

- Each channel has a unique code
- All channels use the same spectrum at the same time
- + bandwidth efficient
- + no coordination or synchronization
- + hard to tap
- + almost impossible to jam
- lower user data rates
- more complex signal regeneration
- Example: UMTS
- Spread spectrum
- U. S. Patent 2'292'387, Hedy K. Markey (a.k.a. Lamarr or Kiesler) and George Antheil (1942)

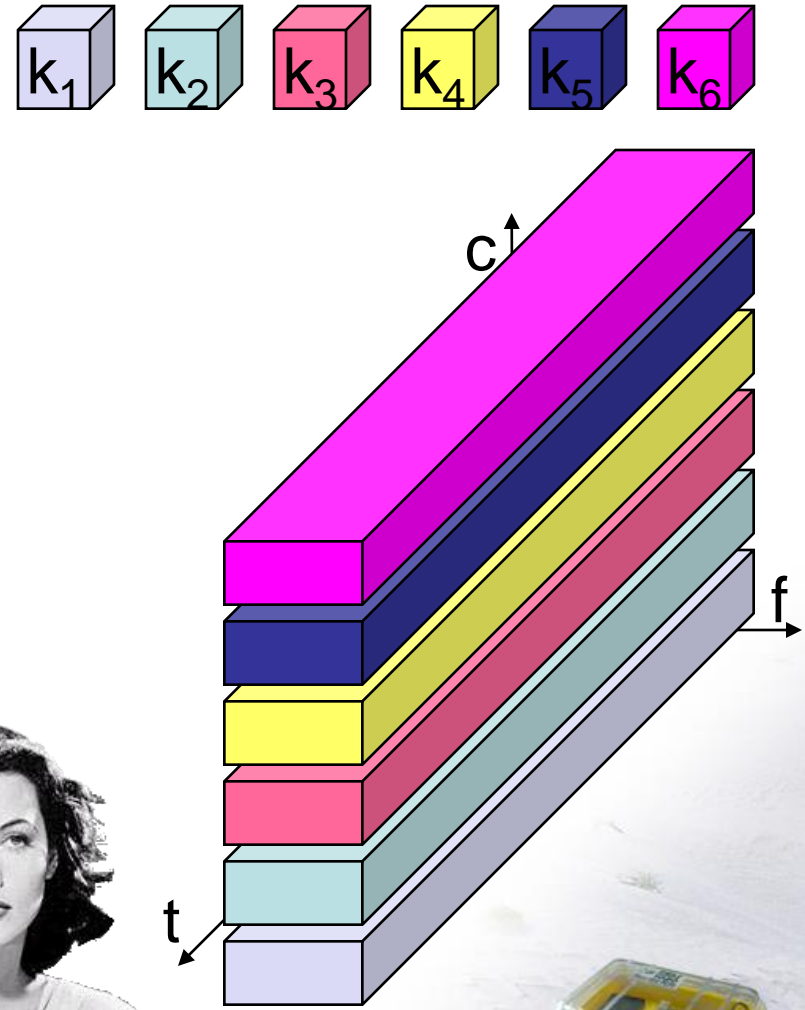

# Cocktail party as analogy for multiplexing

---

- Space multiplex: Communicate in different rooms
- Frequency multiplex: Use soprano, alto, tenor, or bass voices to define the communication channels
- Time multiplex: Let other speaker finish
- Code multiplex: Use different languages and hone in on your language. The “farther apart” the languages the better you can filter the “noise”: German/Japanese better than German/Dutch. Can we have orthogonal languages?

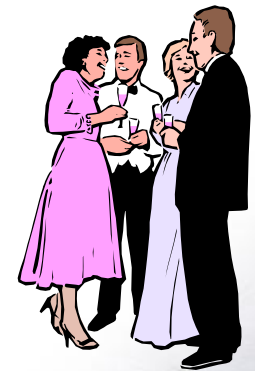

# Periodic Signals

- $g(t) = A_t \sin(2\pi f_t t + \varphi_t)$
- Amplitude  $A$
- frequency  $f$  [Hz = 1/s]
- period  $T = 1/f$
- wavelength  $\lambda$   
with  $\lambda f = c$   
( $c=3 \cdot 10^8$  m/s)
- phase  $\varphi$
  
- $\varphi^* = -\varphi T/2\pi$  [+T]

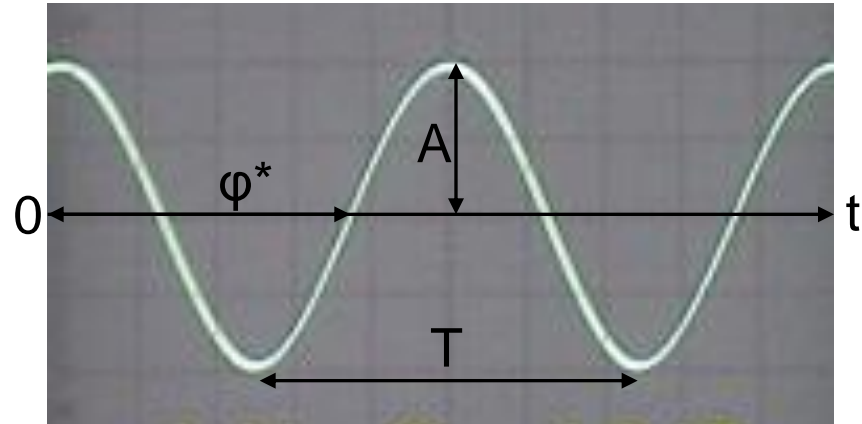



# Modulation and demodulation

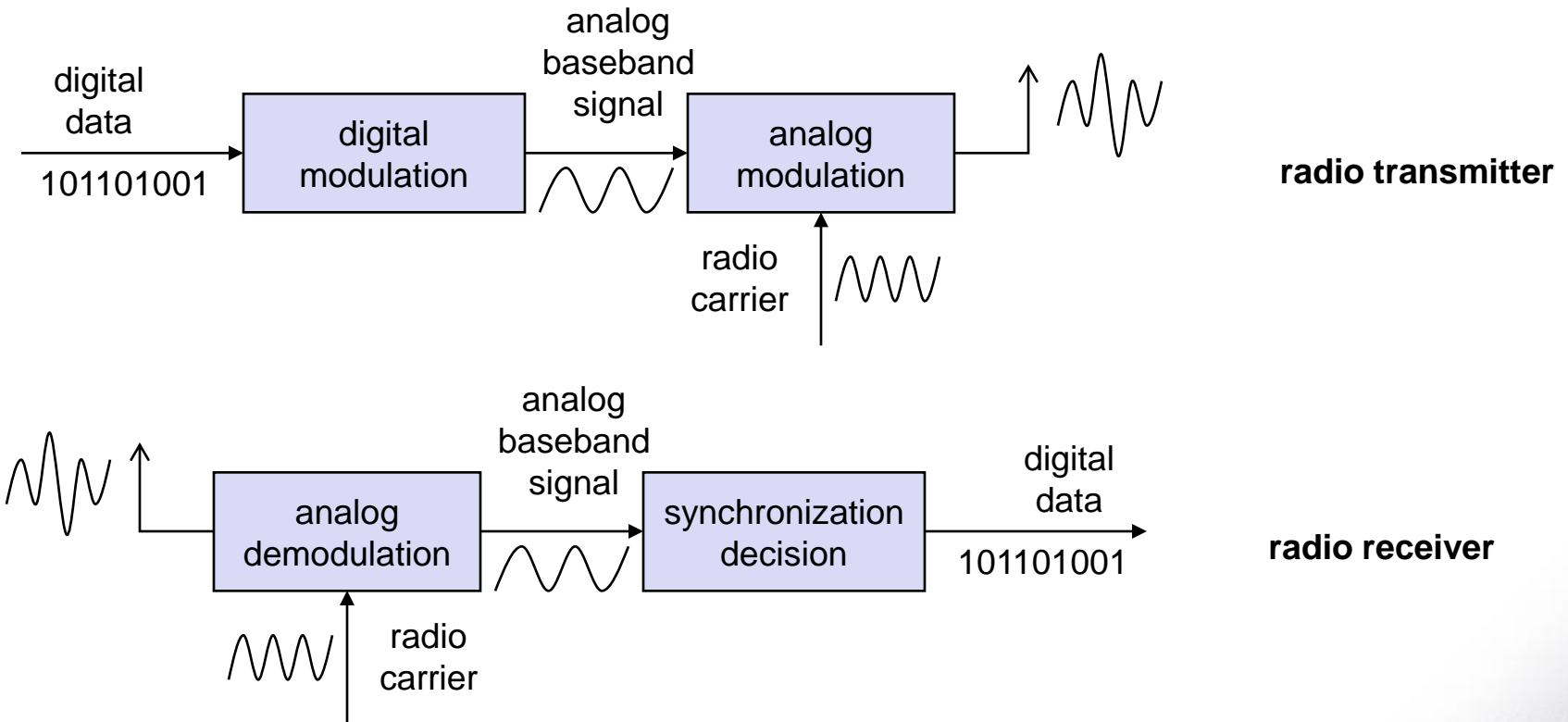

- Modulation in action:

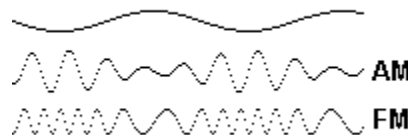

# Digital modulation

- Modulation of digital signals known as Shift Keying

- Amplitude Shift Keying (ASK):
  - very simple
  - low bandwidth requirements
  - very susceptible to interference

- Frequency Shift Keying (FSK):
  - needs larger bandwidth

- Phase Shift Keying (PSK):
  - more complex
  - robust against interference

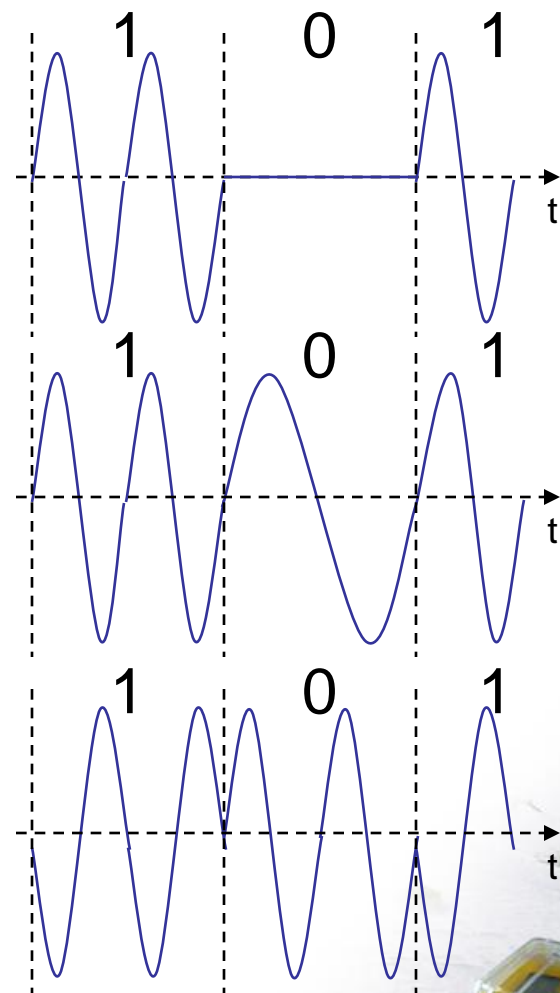

# Different representations of signals

- For many modulation schemes not all parameters matter.

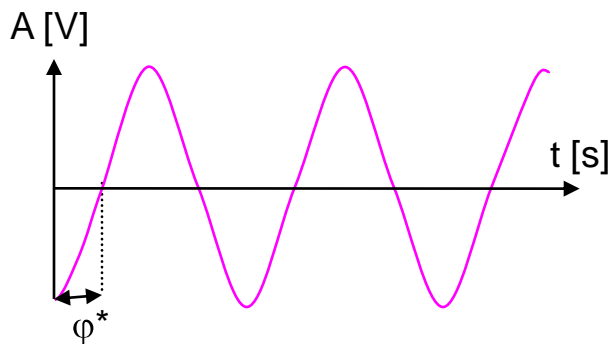

amplitude domain

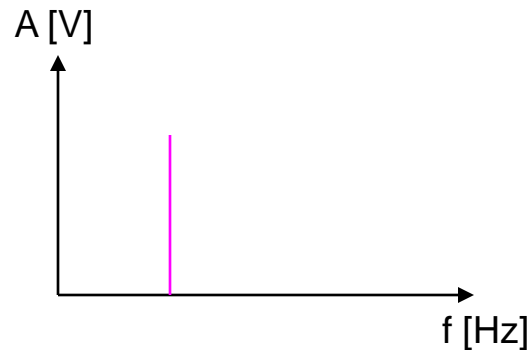

frequency spectrum

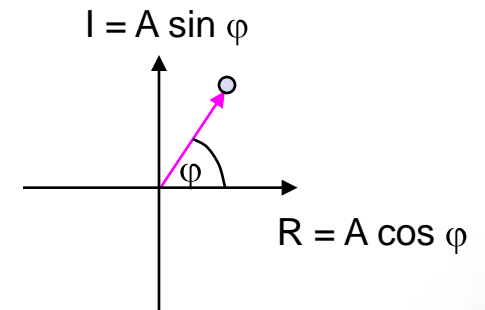

phase state diagram



# Advanced Frequency Shift Keying

---

- MSK (Minimum Shift Keying)
- bandwidth needed for FSK depends on the distance between the carrier frequencies
- Avoid sudden phase shifts by choosing the frequencies such that (minimum) frequency gap  $\delta f = 1/4T$  (where  $T$  is a bit time)
- During  $T$  the phase of the signal changes continuously to  $\pm \pi$
- Example GSM: GMSK (Gaussian MSK)



# Advanced Phase Shift Keying

- BPSK (Binary Phase Shift Keying):

- bit value 0: sine wave
- bit value 1: inverted sine wave
- Robust, low spectral efficiency
- Example: satellite systems

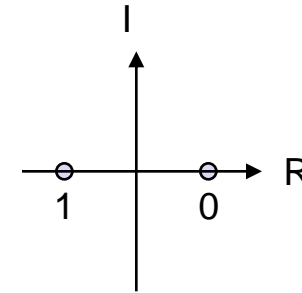

- QPSK (Quadrature Phase Shift Keying):

- 2 bits coded as one symbol
- symbol determines shift of sine wave
- needs less bandwidth compared to BPSK
- more complex

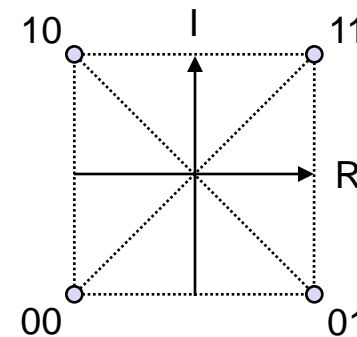

- Dxxxx (Differential xxxx)



# Modulation Combinations

- Quadrature Amplitude Modulation (QAM)
- combines amplitude and phase modulation
- it is possible to code  $n$  bits using one symbol
- $2^n$  discrete levels,  $n=2$  identical to QPSK
- bit error rate increases with  $n$ , but less errors compared to comparable PSK schemes
- Example: 16-QAM (4 bits = 1 symbol)
- Symbols 0011 and 0001 have the same phase, but different amplitude. 0000 and 1000 have different phase, but same amplitude.
- Used in 9600 bit/s modems

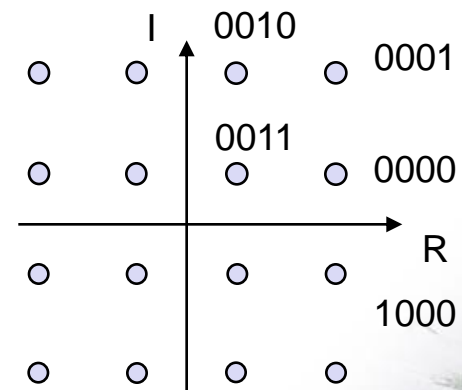

# Ultra-Wideband (UWB)

- An example of a new physical paradigm.
- Discard the usual dedicated frequency band paradigm.
- Instead share a large spectrum (about 1-10 GHz).
- Modulation: Often pulse-based systems. Use extremely short duration pulses (sub-nanosecond) instead of continuous waves to transmit information. Depending on application 1M-2G pulses/second

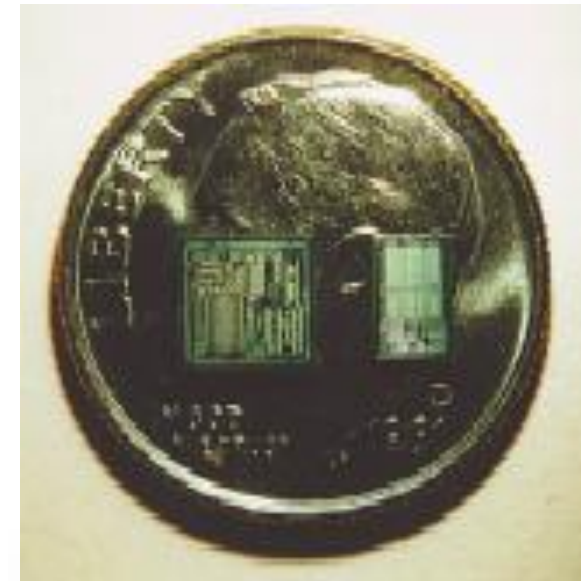
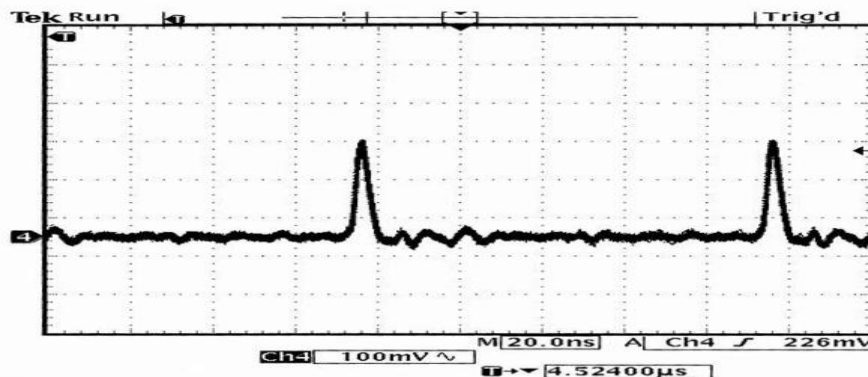

# UWB Modulation

- PPM: Position of pulse
- PAM: Strength of pulse
- OOK: To pulse or not to pulse
- Or also pulse shape

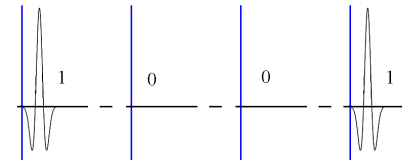
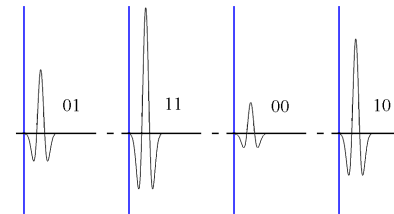
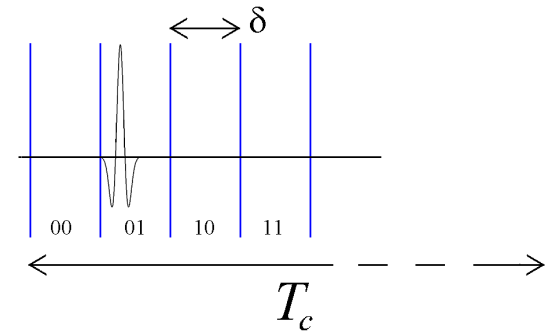



# Ad-Hoc Networks...

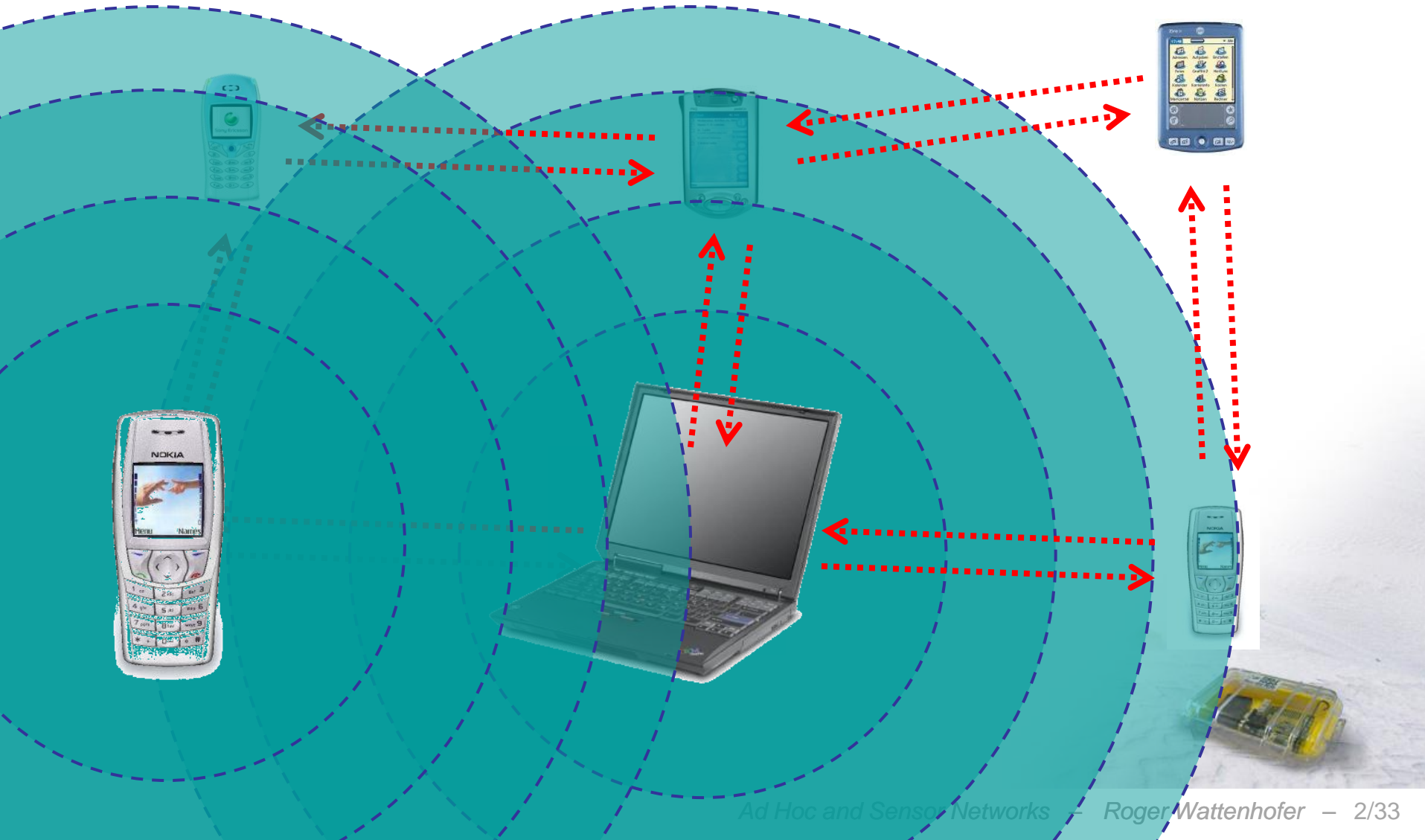

# ...Modeled by means of Graphs

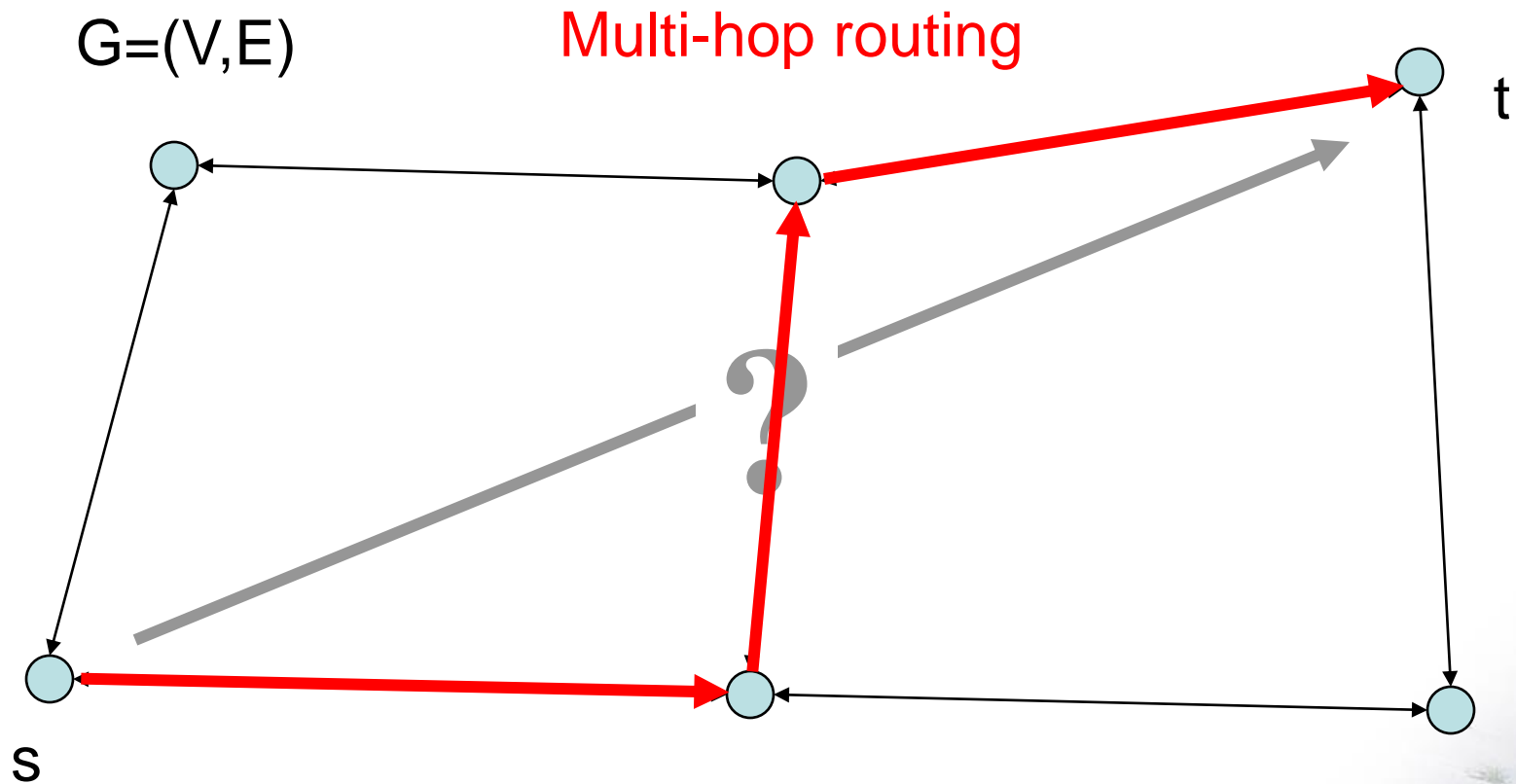

- Laptops, PDA's, cars, soldiers
  - All-to-all **routing**
  - Often with **mobility** (MANET's)
  - **Trust/Security** an issue
    - No central coordinator
  - Maybe high **bandwidth**
- **Tiny nodes**: 4 MHz, 32 kB, ...
  - Broadcast/Echo from/to sink
  - Usually no mobility
    - but link failures
  - One administrative control
  - Long lifetime → **Energy**



# Mobile Ad Hoc Networks (MANET)

- Nodes move

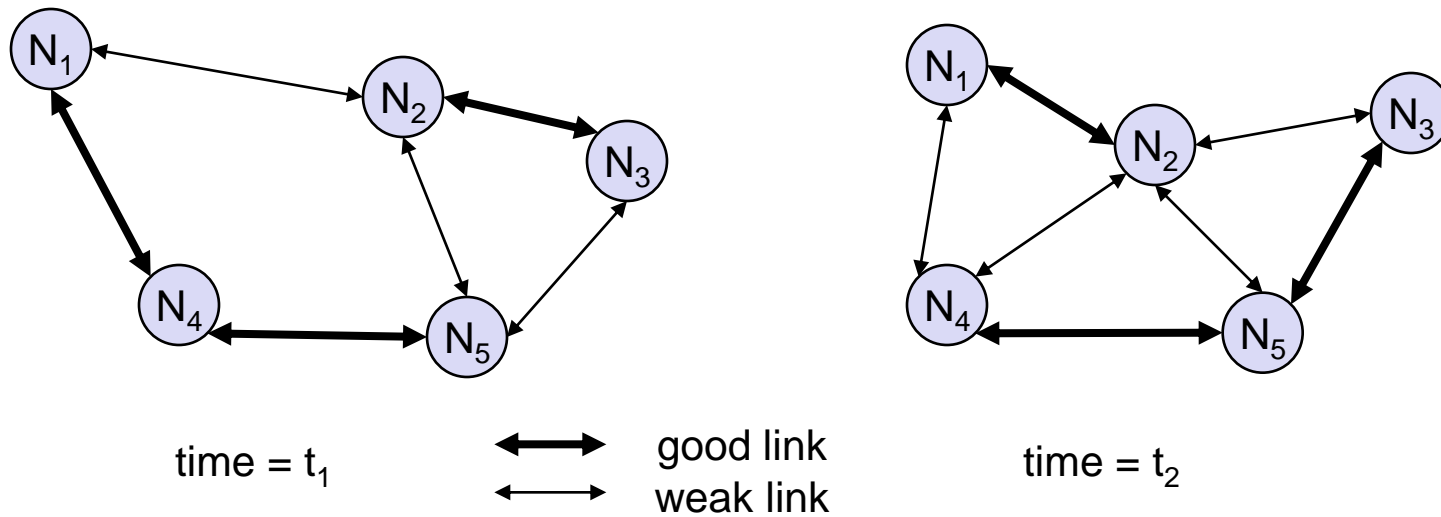

- Even if nodes do not move, graph topology might change



# An ad hoc network as a graph

- A node is a (mobile) station
- Iff node  $v$  can receive node  $u$ , the graph has an arc  $(u,v)$
- These arcs can have weights that represent the signal strength
- Close-by nodes have MAC issues such as hidden/exposed terminal problems
- Is a graph really an appropriate model for ad hoc and sensor networks?

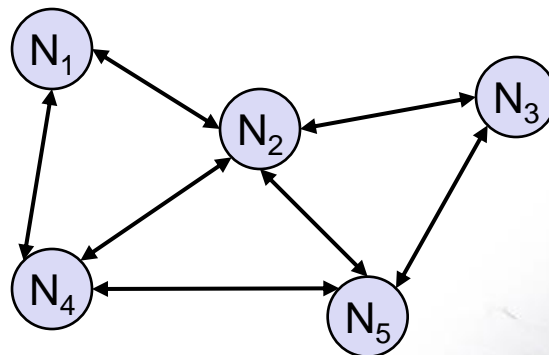
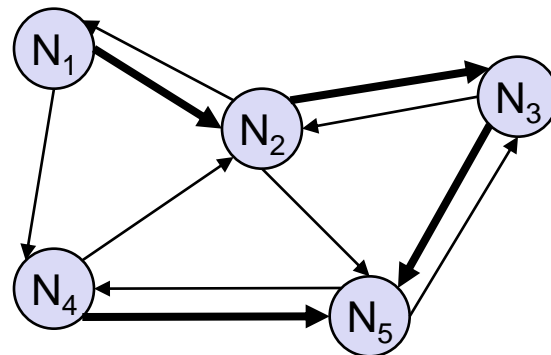

→ We need to look at models first!



# Why are models needed?

- Formal models help us **understanding** a problem
- Formal proofs of correctness and efficiency
- Common basis to compare results
- Unfortunately, for ad hoc and sensor networks, a myriad of models exist, most of them make sense in some way or another. On the next few slides we look at a few selected models

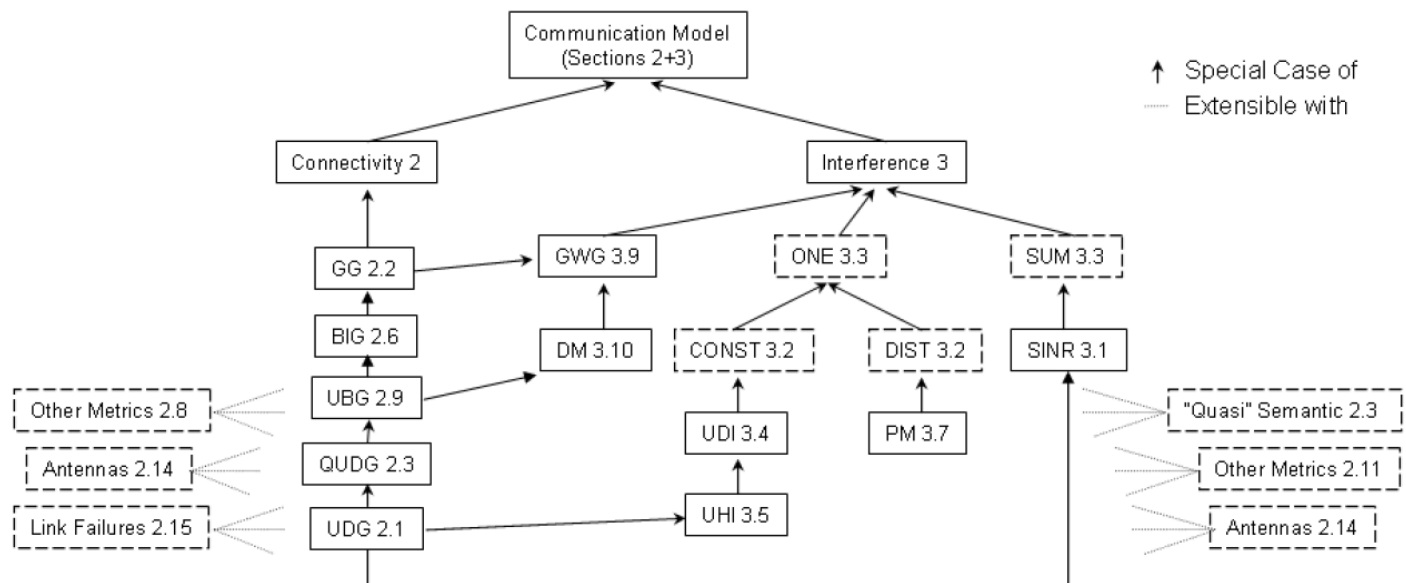

# Unit Disk Graph (UDG)

---

- Classic computational geometry model, special case of disk graphs

- All nodes are points in the plane, two nodes are connected iff (if and only if) their distance is at most 1, that is  $\{u,v\} \in E \Leftrightarrow |u,v| \leq 1$

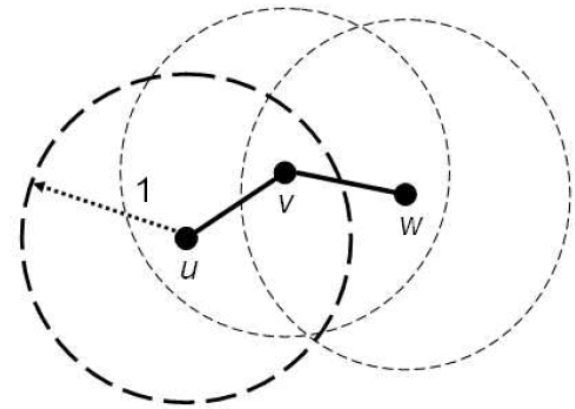

- + Very simple, allows for strong analysis
- Not realistic: “If you gave me \$100 for each paper written with the unit disk assumption, I still could not buy a radio that is unit disk!”
- Particularly bad in obstructed environments (walls, hills, etc.)
- Natural extension: 3D UDG



# Quasi Unit Disk Graph (UDG)

- Two radii, 1 and  $\rho$ , with  $\rho \leq 1$ 
  - $|u,v| \leq \rho \Leftrightarrow \{u,v\} \in E$
  - $1 < |u,v| \Leftrightarrow \{u,v\} \notin E$
  - $\rho < |u,v| \leq 1 \Leftrightarrow$  **it depends!**
    - ... on an adversary
    - ... on probabilistic model
    - ...

- + Simple, analyzable
- + More realistic than UDG
- Still bad in obstructed environments (walls, hills, etc.)
- Natural extension: 3D QUDG

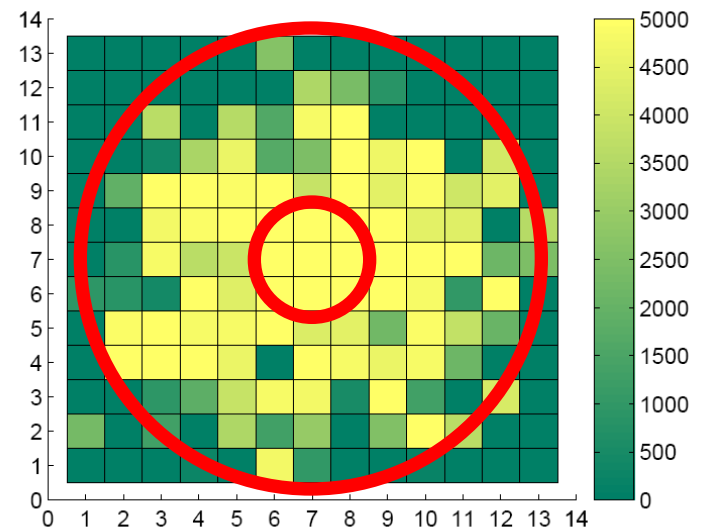
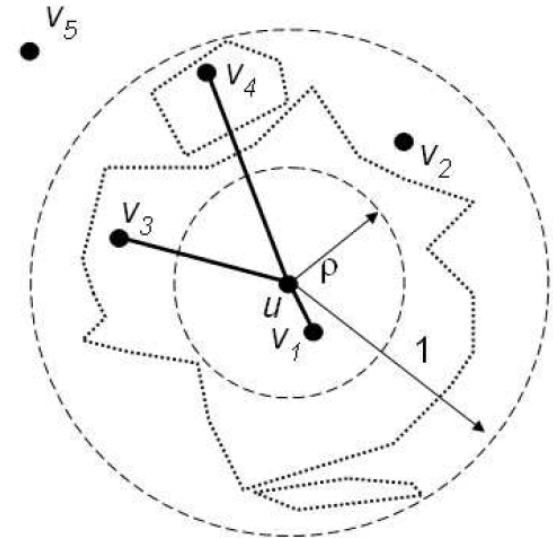



# Bounded Independence Graph (BIG)

- How realistic is QUDG?
  - $u$  and  $v$  can be close but not adjacent
  - model requires very small  $\rho$  in obstructed environments (walls)

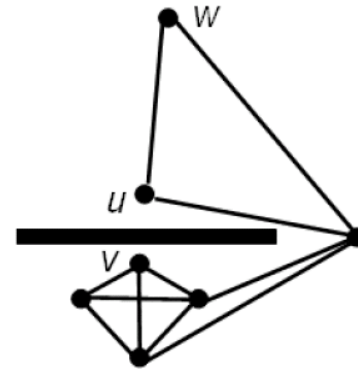

- However: in practice, neighbors are often also neighboring

- Solution: BIG Model

- Bounded independence graph
- Size of any independent set grows polynomially with hop distance  $r$
- e.g.  $O(r^2)$  or  $O(r^3)$

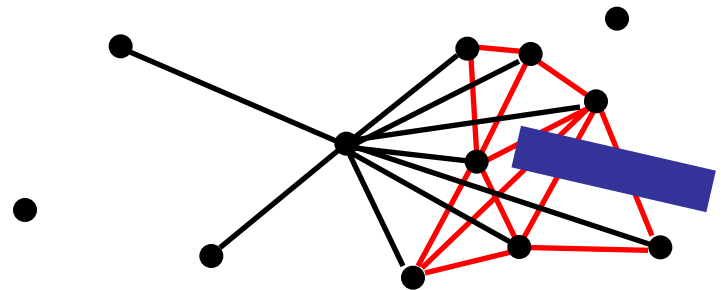

# Unit Ball Graph (UBG)

---

- $\exists$  **metric**  $(V, d)$  with **constant doubling dimension**.
- **Metric**: Each edge has a distance  $d$ , with
  1.  $d(u, v) \geq 0$  (non-negativity)
  2.  $d(u, v) = 0$  iff  $u = v$  (identity of indiscernibles)
  3.  $d(u, v) = d(v, u)$  (symmetry)
  4.  $d(u, w) \leq d(u, v) + d(v, w)$  (triangle inequality)
- **Doubling dimension**:  $\log(\# \text{balls of radius } r/2 \text{ to cover ball of radius } r)$ 
  - **Constant**: you only need a constant number of balls of half the radius
- **Connectivity graph** is same as UDG:  
such that:  $d(u, v) \leq 1 : (u, v) \in E$   
 $d(u, v) > 1 : (u, v) \notin E$

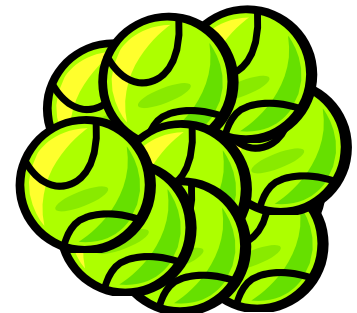

# Connectivity Models: Overview

General Graph

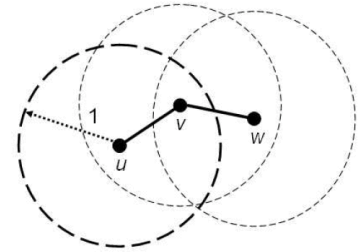

UDG

← too pessimistic

too optimistic →

Bounded Independence

Unit Ball Graph

Quasi UDG

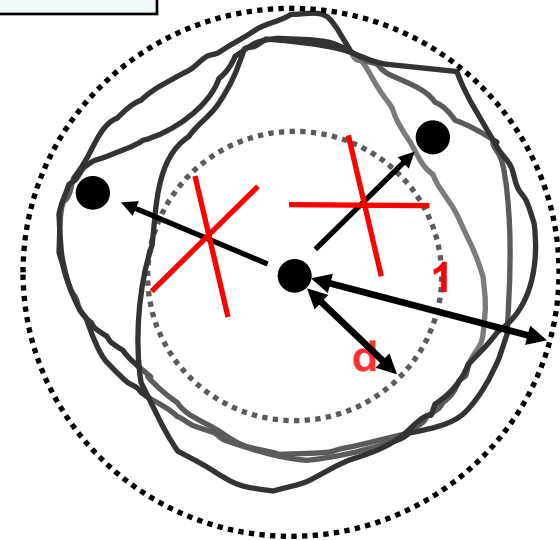
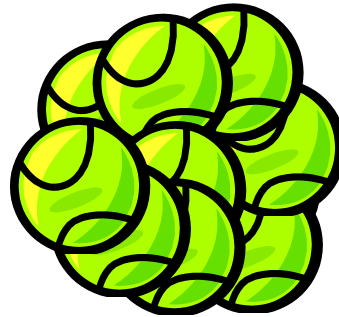
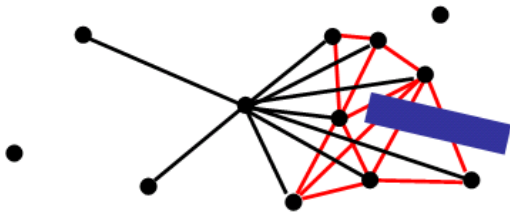

# Models are related

- BIG is special case of general graph,  $BIG \subseteq GG$
- $UBG \subseteq BIG$  because the size of the independent sets of any UBG is polynomially bounded
- $QUDG(\text{constant } \rho) \subseteq UBG$
- $QUDG(\rho=1) = UDG$

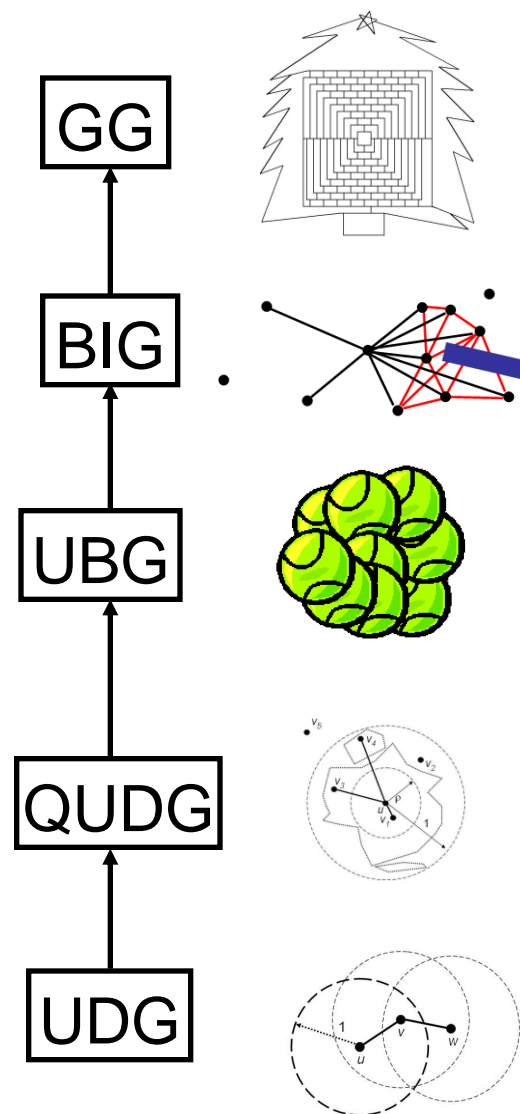

# Beyond Connectivity: Protocol Model (PM)

- For lower layer protocols, a model needs to be specific about interference. A simplest interference model is an extension of the UDG. In the protocol model, a transmission by a node in at most distance 1 is received iff there is no conflicting transmission by a node in distance at most  $R$ , with  $R \geq 1$ , sometimes just  $R = 2$ .
- + Easy to explain
- Inherits all major drawbacks from the UDG model
- Does not easily allow for designing distributed algorithms
- Lots of interfering transmissions just outside the interference radius  $R$  do not sum up.
- Can be extended with the same extensions as UDG, e.g. QUDG

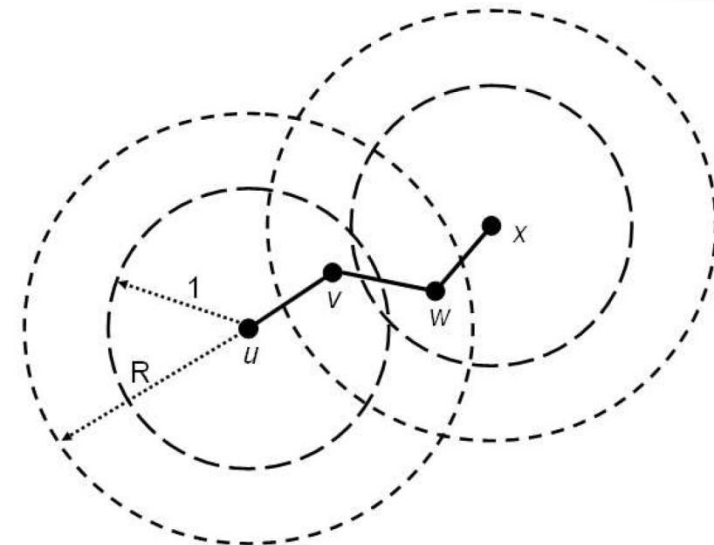

# Hop Interference (HI)

- An often-used interference model is hop-interference. Here a UDG is given. Two nodes can communicate directly iff they are adjacent, and if there is no concurrent sender in the  $k$ -hop neighborhood of the receiver (in the UDG). Sometimes  $k=2$ .
- Special case of the protocol model, inheriting all its drawbacks
- + Simple
- + Allows for distributed algorithms
- A node can be close but not produce any interference (see pic)
- Can be extended with the same extensions as UDG, e.g. QUDG

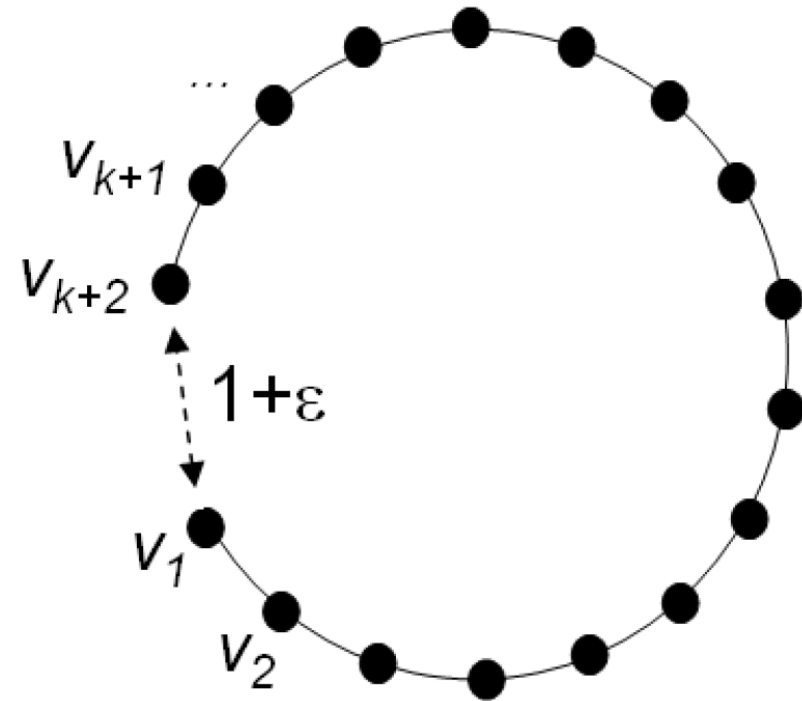

# Models Beyond Graphs

- Clients A and B want to send (max. rate  $x$  kb/s)
- Assume there is a **single frequency**
- What total throughput („spatial reuse“) can be achieved...?

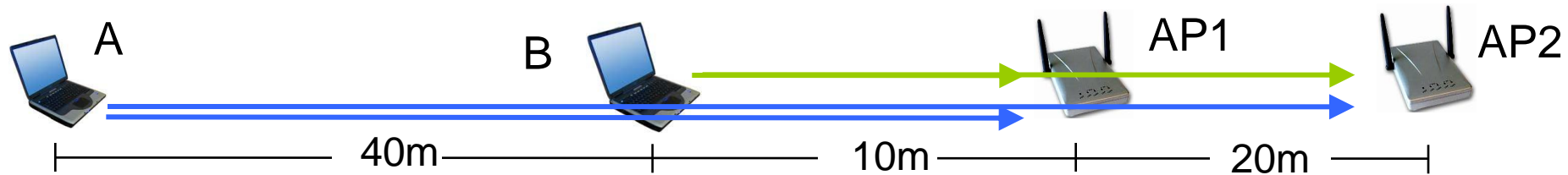

Total throughput at most:  $x$  kb/s

In graph-based models...

no spatial reuse seems possible...

# Signal-to-Interference-Plus-Noise Ratio (SINR, Physical M.)

- Communication theorists study complex fading and **signal-to-noise-plus-interference (SINR)-based models**
- Simplest case:
  - packets can be decoded if SINR is larger than  $\beta$  at receiver

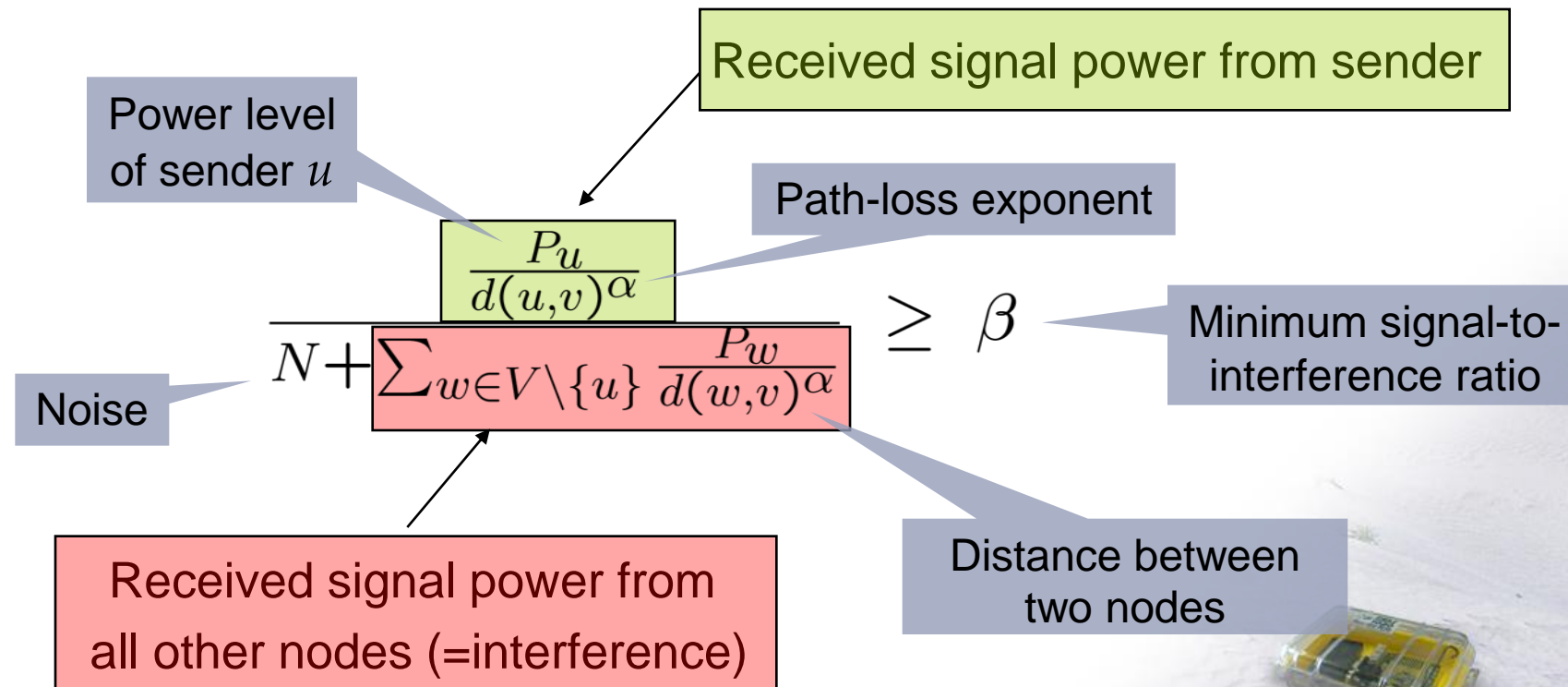



# SINR Example

A sends to AP2, B sends to AP1 → (max. rate  $x$  kb/s)

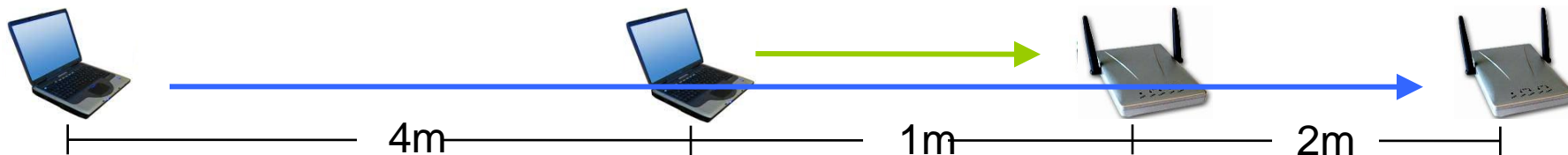

- Assume a **single frequency** (and no fancy decoding techniques!)
- Let  $\alpha=3$ ,  $\beta=3$ , and  $N=10\text{nW}$
- Set the transmission powers as follows  $P_B = -15$  dBm and  $P_A = 1$  dBm

$$\text{SINR of A at AP2: } \frac{1.26\text{mW}/(7\text{m})^3}{0.01\mu\text{W} + 31.6\mu\text{W}/(3\text{m})^3} \approx 3.11 \geq \beta$$

$$\text{SINR of B at AP1: } \frac{31.6\mu\text{W}/(1\text{m})^3}{0.01\mu\text{W} + 1.26\text{mW}/(5\text{m})^3} \approx 3.13 \geq \beta$$

**A total throughput of 2x kb/s is possible !**

# SINR Discussion

---

- + In contrast to other low-layer models such as PM the SINR model allows for interference that does sum up. This is certainly closer to reality. However, SINR is not reality. In reality, e.g., competing transmissions may even cancel themselves, and produce less interference. In that sense the SINR model is worse than reality.
- SINR is complicated, hard to analyze
- Similarly as PM, SINR **does not really allow for distributed algorithms**
- Despite being complicated, it is a total simplification of reality. If we remove the “I” from the SINR model, we have a UDG, which we know is not correct. Also, in reality, e.g. the signal fluctuates over time. Some of these issues are captured by more complicated fading channel models.



# More on SINR

---

- Often there is more than a single threshold  $\beta$ , that decides whether reception is possible or not. In many networks, a **higher S/N ratio** allows for more advanced modulation and coding techniques, allowing for **higher throughput** (e.g. Wireless LAN)
- However, even more is possible: For example, assume that a receiver is receiving two transmissions, transmission  $T_1$  being much stronger than transmission  $T_2$ . Then  $T_2$  has a terrible S/N ratio. However, we might be able to **subtract** the strong  $T_1$  from the total signal, and with  $T - T_1 = T_2$ , and hence also get  $T_2$ .
- These are just two examples of how to get more than you expect.



# Overview of some models

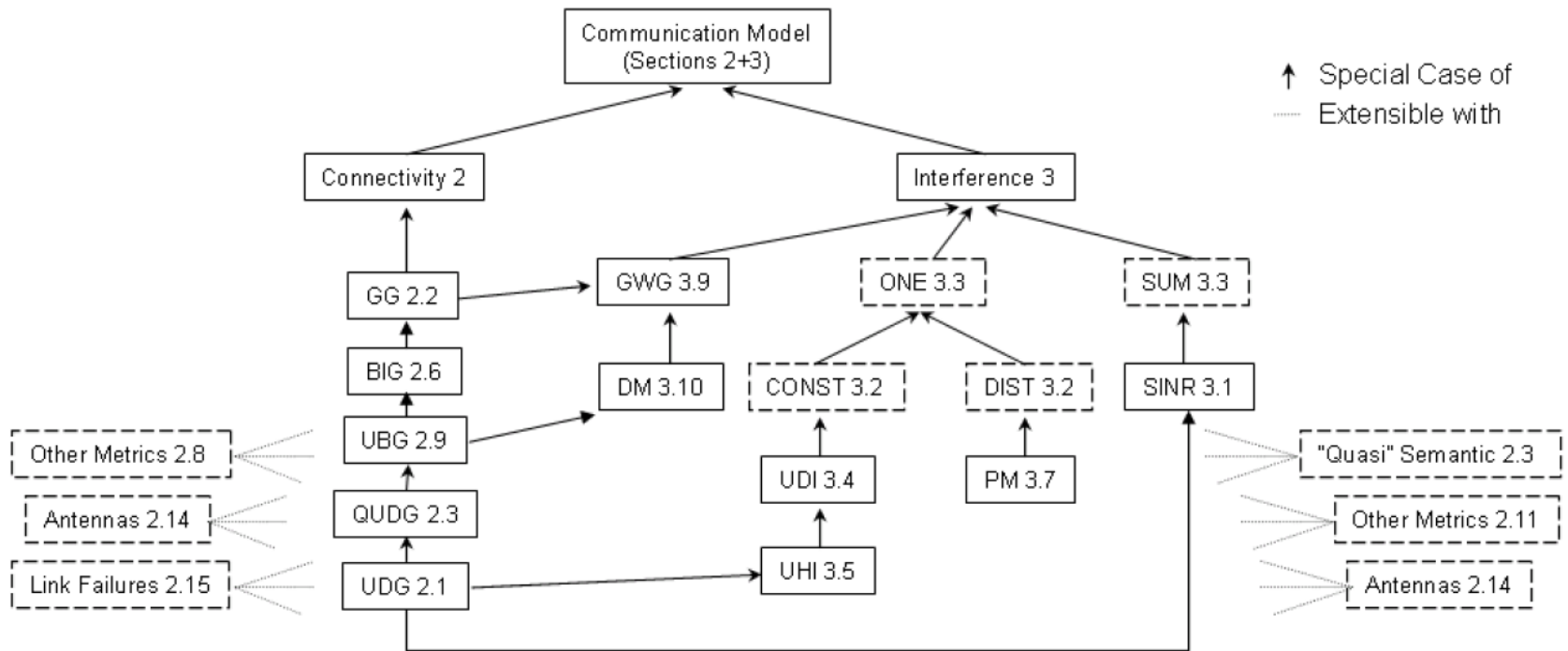

- Try to proof **correctness** in an as “high” as possible model
- For **efficiency**, a more optimistic (“lower”) model might be fine

# Dozens of issues beyond connectivity/interference

- How are the nodes deployed?
  - By a random process vs. we don't know/in any way/worst-case

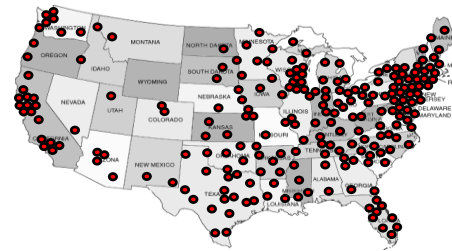
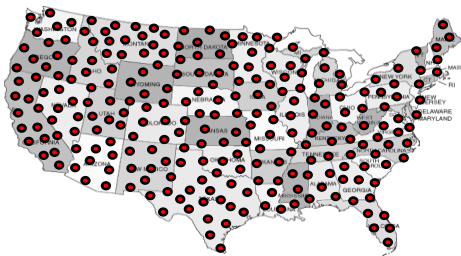

- Do the nodes know their position (e.g. GPS)?
- Are the nodes mobile? In what way?
- What kind of antenna do we have?
- What are the traffic patterns that we expect?
- ...



# Rating (of Models)

---

- Area maturity



- Practical importance



- Theoretical importance



# Open Problem

---

- Some modeling issues are better understood than others. E.g., we are quite happy with some of the more advanced connectivity models such as BIG or UBG, or even QUDG.
- However, we lack a simple and realistic models for other things, such as
  - connectivity and interference: SINR is at the same time too simplistic and also on the fringe of being intractable, in particular when building protocols
  - or mobility: the usual models such as random waypoint are not really practical, but also not theoretically tangible.

